

APPLICATION	AXLE	SCALE	REV.	DATE	SHIM 089
	R	100%	00	26/05/2012	
ALPINA BMW : 3 SERIES, 5 SERIES, 7SERIES, 8 SERIES, X3, X5, Z4,Z8 LAND ROVER : RANGE ROVER MASERATI : GHIBLI II, QUATTROPORTE	W.V.A. 21282 21284 21285 21487	FMSI D0683	O.E. 34 211 162 862 34 211 163 324 34 211 163 326 34 211 163 833 34 211 164 581 34 211 164 582 34 216 750 160 34 216 752 632 34 216 761 247 34 216 761 248	 MECCANICHE MARCO MORETTO S.R.L. BRAKE PADS COMPONENTS	

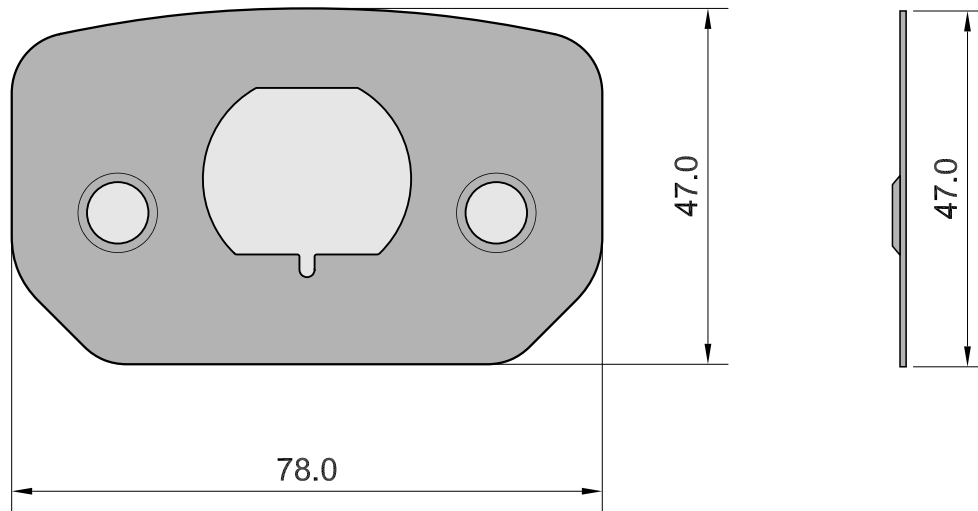

Drawing in CAD corrections are not allowed

TOLLERANCE: ± 0.5