

APPLICATION	AXLE	SCALE	REV.	DATE	SHIM 1003
	F	100%	00	21/11/2014	
AUDI: A3 III,A3 III LIMOUSINE,A3 QUATTRO, A3 III QUATTRO LIMOUSINE, S3 III QUATTRO SEAT: LEON III,ALHAMBRA II SKODA: OCTAVIA III VOLKSWAGEN: GOLF VII, GOLF VII VARIANT CC, PASSAT VII,PASSAT COUPE', SHARAN II	W.V.A. 24738 25086	FMSI	O.E.	 MECCANICHE MARCO MORETTO S.R.L. BRAKE PADS COMPONENTS	

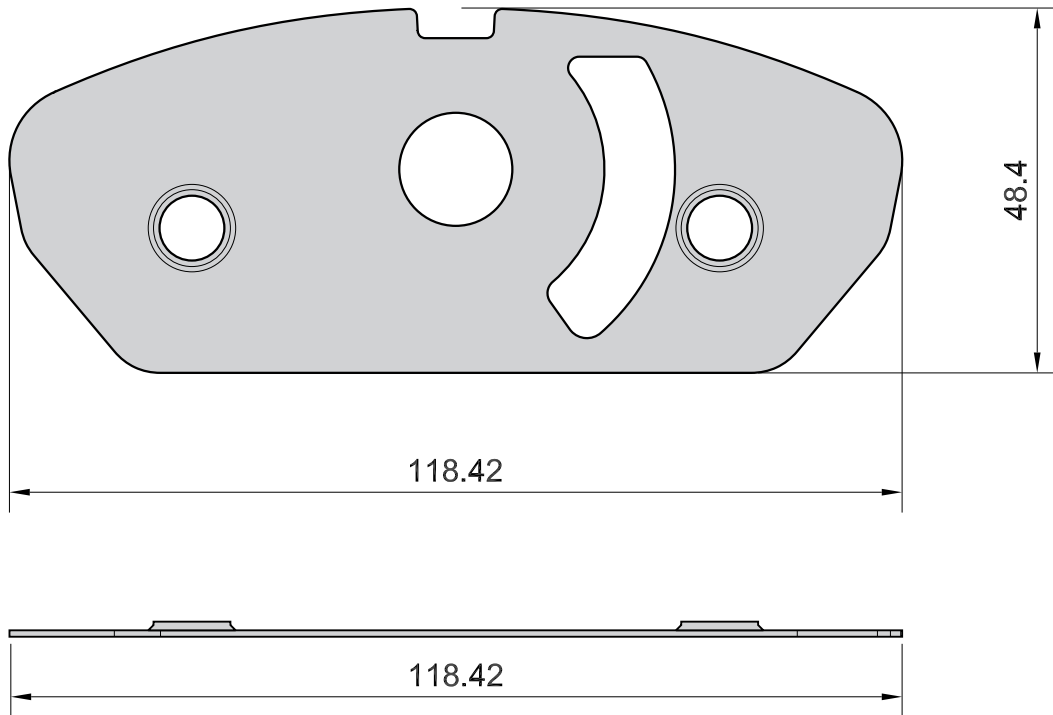

Drawing in CAD corrections are not allowed
TOLLERANCE: ± 0.5