

APPLICATION	AXLE	SCALE	REV.	DATE	SHIM 733
	F	100%	00	19/10/2015	
FIAT:IDEA,500 OPEL:CORSA	W.V.A. 23705 23706 23707 23979 23982	FMSI D1616	O.E.		 MECCANICHE MARCO MORETTO S.R.L. BRAKE PADS COMPONENTS

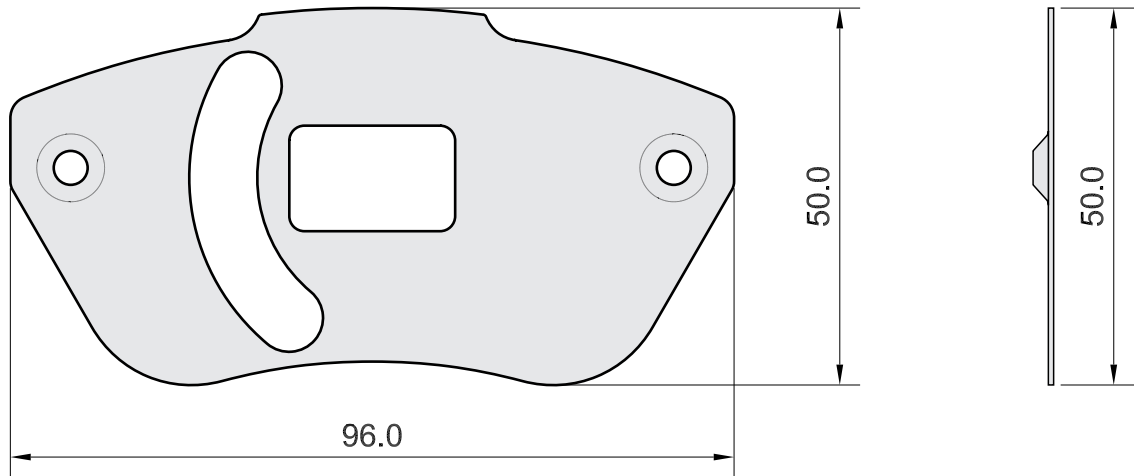

Drawing in CAD corrections are not allowed

TOLLERANCE: ± 0.5