

APPLICATION FIAT OPEL	AXLE	SCALE	REV.	DATE	SHIM 798
	F	100%	00	19/10/2015	
	W.V.A. 23982		FMSI	O.E.	 MECCANICHE MARCO MORETTO S.R.L. BRAKE PADS COMPONENTS

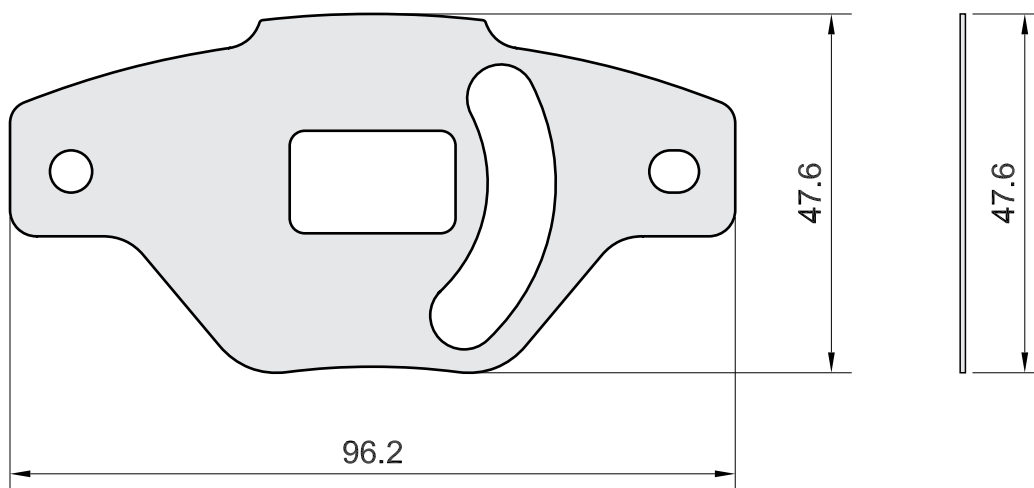

Drawing in CAD corrections are not allowed
TOLLERANCE: ± 0.5